

SUMTOR

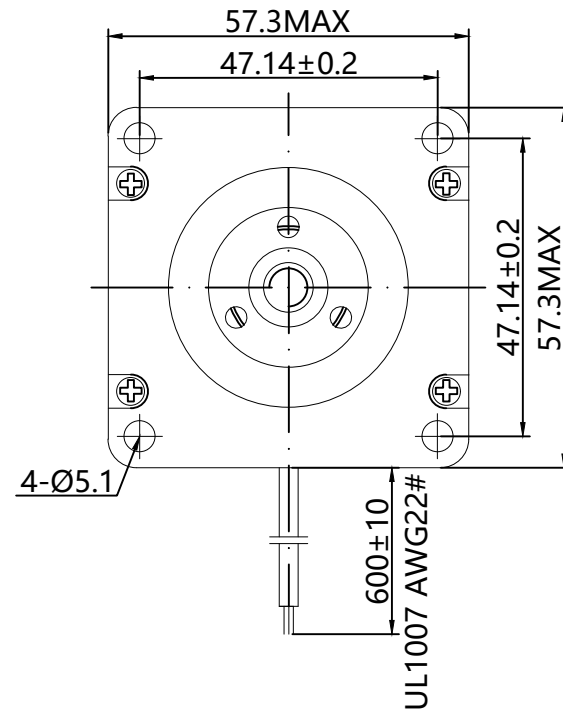

绕组接线图

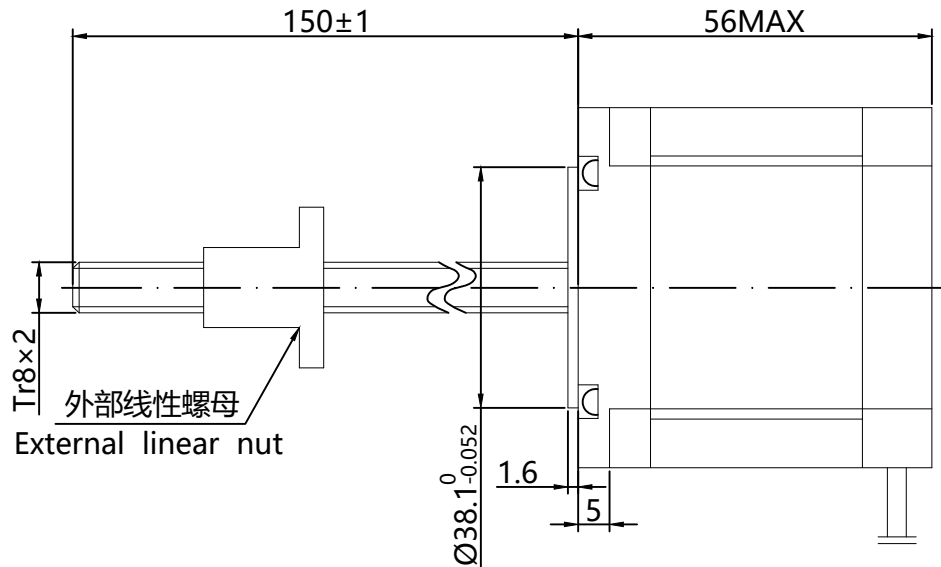
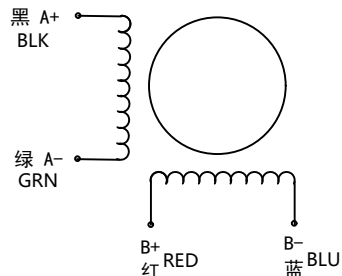

MR003-A 白色POM
(White POM)

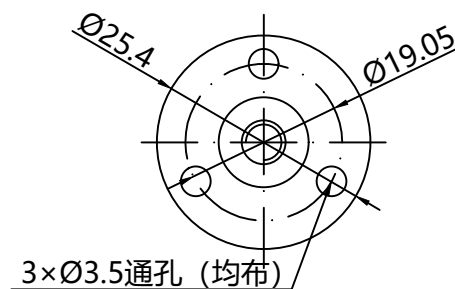
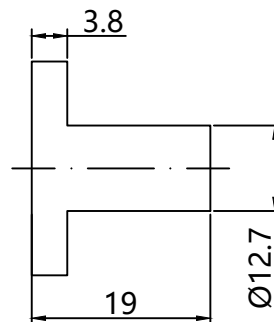

外形尺寸: unit=mm

Electrical Specifications			COMMENT	螺杆规格 The screw shaft specifications	
STEP ANGLE	步距角	1.8 ° /STEP			规格Modle
RATED VOLTAGE	相电压	2.7 V		步长Resolution	0.01mm
CURRENT	相电流	3.0 A/PHASE		导程Lead	2
RESISTANCE	相电阻	0.9 Ω/PHASE		螺距Screw head	2
INDUCTANCE	相电感	2.5 mH/PHASE		型号Nut NO:	WHA
HOLDING TORQUE	静力矩	120 N.cm			
DETENT TORQUE	定位力矩	450 g.cm			
ROTOR INERTIA	转动惯量	280 g.cm ²			
MOTOR WEIGHT	重量	710 g			

序号	数量	名称/代号/材料			
设计	审核	批准	日期	图号	比例
邹志仁					1:1
无锡三拓电气设备有限公司 SUMTOR(Wuxi) Electric CO.,Ltd		57HZ5630T8C2-150			
项目			版本	V1.0	